

4/3 servo solenoid valves with positive overlap and position feedback (Lvdt AC/AC)

RE 29022/01.05
Replaces: 05.04

1/14

Type 4WRP ..E.. / ..W..

Size 6, 10
Unit series 1X
Maximum working pressure of P, A, B 315 bar, T 250 bar
Nominal flow rate 6...28 l/min (NG6), 32...63 l/min (NG10)



List of contents

Contents	Page
Features	1
Ordering data and scope of delivery	2
Preferred types	2
Function, sectional diagram, symbols	3 and 4
Technical data	5 and 6
Valve with external trigger electronics	7 and 8
Characteristic curves	9 to 11
Unit dimensions	12 and 13



Features

- Directly operated NG6 and 10 valves with positive overlap and external valve electronics
- Actuated on both sides, symbol E or W
- Control solenoids with A-side position feedback (Lvdt AC/AC)
- Suitable for use in electrohydraulic controls in production plants
- For subplate attachment, mounting hole configuration NG6 to ISO 4401-03-02-0-94 and NG10 with additional "L" port to ISO 4401-05-06-0-94
- External trigger electronics (order separately), see catalog section RE 30048 and RE 30047
- Solenoid and position transducer connectors included in scope of delivery
- Subplates as per catalog section RE 45053 and RE 45055 (order separately)

Variants on request

- For standard applications
- Special symbols and characteristic curves

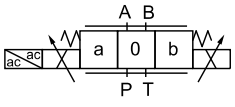
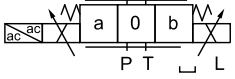
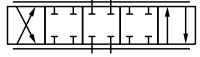
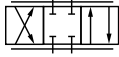
Ordering data and scope of delivery

	4WRP				S - 1X / G24	Z4 / M	*	
For external trigger electronics	= no code						Further information in plain text	
Size 6	= 6						M = NBR seals, suitable for mineral oils (HL, HLP) to DIN 51524	
Size 10	= 10							
Symbols								Electrical connection
4/3-way version								with plug to DIN 43560-AM2 with line socket, line socket included in scope of delivery
							Z4 =	
NG6								with plug to DIN 43560-AM2 with line socket, line socket included in scope of delivery
							G24 =	
NG10 ¹⁾								+24 V DC
							1X =	
= E								Unit series (installation and connection dimensions unchanged)
							S =	
E1								Flow characteristic
							Progressive	
= W								Nominal flow rate at 10 bar valve pressure difference
							(5 bar per metering notch)	
W1								
¹⁾ Type 4WRP 10								
Mounting hole configuration with additional "L" port								
With symbol E1- and W1-								
P → A = q _{v,max}				B → T = q _{v/2}				
P → B = q _{v/2}				A → T = q _{v,max}				
	Size 6		Size 10					
	06 = 6 l/min		32 = 32 l/min					
	08 = 8 l/min		63 = 63 l/min					
	14 = 14 l/min							
	16 = 16 l/min							
	28 = 28 l/min							

Preferred types (available at short notice)

Type 4WRP 6	Material No.	Type 4WRP 10	Material No.
Symbol E		Symbol E, E1	
4WRP 6 E 08S -1X/G24Z4/M 755 *)	0 811 404 101	4WRP 10 E 32S -1X/G24Z4/M	0 811 404 003
4WRP 6 E 16S -1X/G24Z4/M 755 *)	0 811 404 100	4WRP 10 E 63S -1X/G24Z4/M	0 811 404 001
4WRP 6 E 28S -1X/G24Z4/M	0 811 404 119	4WRP 10 E1 63S -1X/G24Z4/M	0 811 404 086
Symbol W		Symbol W, W1	
4WRP 6 W 06S -1X/G24Z4/M	0 811 404 126	4WRP 10 W 32S -1X/G24Z4/M	0 811 404 081
4WRP 6 W 14S -1X/G24Z4/M	0 811 404 120	4WRP 10 W 63S -1X/G24Z4/M	0 811 404 080
4WRP 6 W 28S -1X/G24Z4/M	0 811 404 121	4WRP 10 W1 63S -1X/G24Z4/M	0 811 404 087

*) Progressive characteristic curve, with triangular notch (standard = semicircular notch)

Function, sectional diagram

Type 4WRP 6..

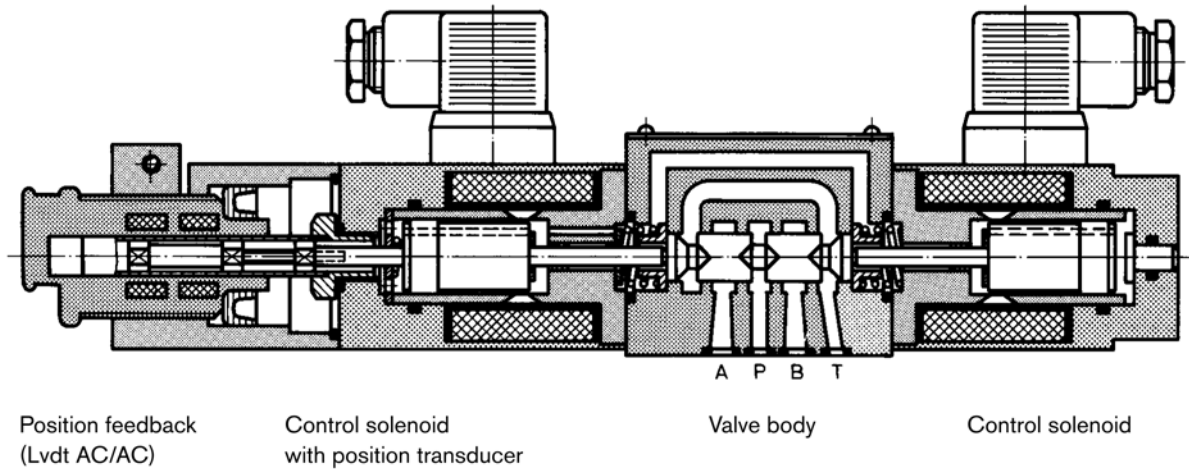

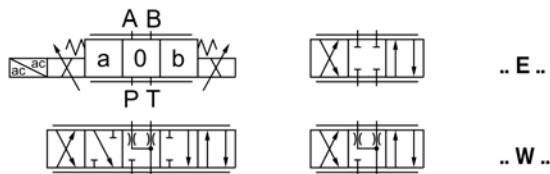

Symbols

Position transducer: A-side

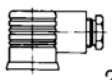
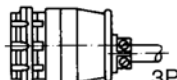

Accessories

(4 x)  M5 x 30 DIN 912-10.9	Fastening bolts	2 910 151 166
 	VT-VRPA2-527-10 / V0 / RTP, see RE 30048	0 811 405 119
	VT-VRPA2-527-10 / V0 / RTS, see RE 30047	0 811 405 137
  2P+PE 3P	Line socket 2P+PE (M16 x 1.5) and 3P (Pg7) included in scope of delivery, see also RE 08008	

Testing and service equipment

- Test box type VT-PE-TB1, see RE 30063
- Test adapter type VT-PA-3, see RE 30070

Function, sectional diagram

Type 4WRP 10 ..

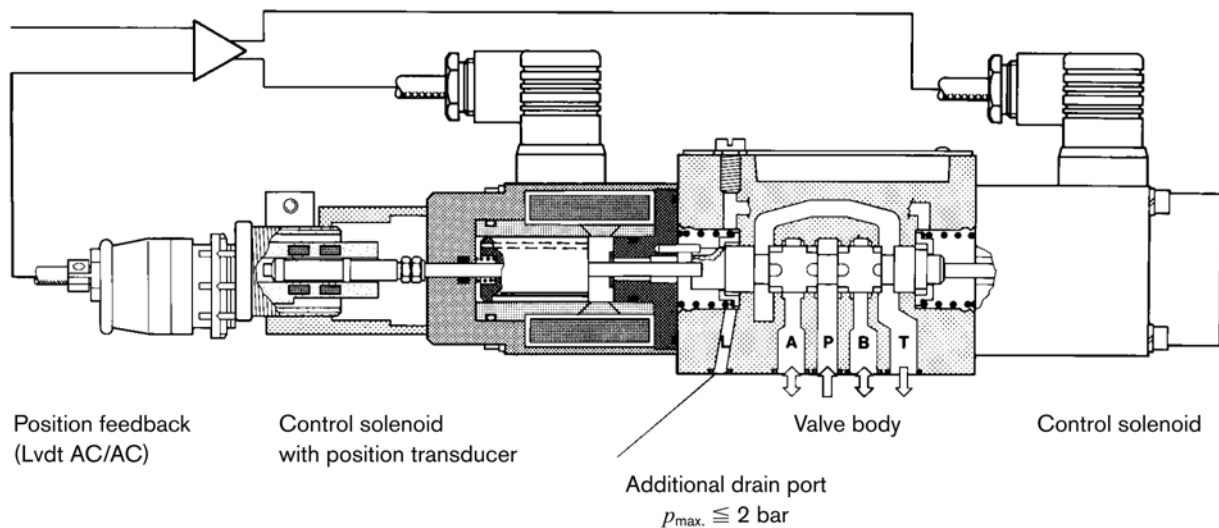

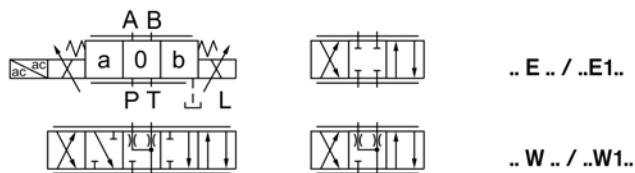

Symbols

Position transducer: A-side

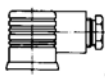
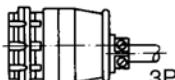

Accessories

(4 x) M6 x 35 DIN 912-10.9	Fastening bolts	2 910 151 207
 	VT-VRPA2-537-10 / V0 / RTP, see RE 30048	0 811 405 120
	VT-VRPA2-537-10 / V0 / RTS, see RE 30047	0 811 405 138
 	Line socket 2P+PE (M16 x 1.5) and 3P (Pg7) included in scope of delivery, see also RE 08008	

Testing and service equipment

- Test box type VT-PE-TB1, see RE 30063
- Test adapter type VT-PA-3, see RE 30070

Technical data (type 4WRP 6 ..)**General**

Construction	Spool type valve	
Actuation	Proportional solenoid with position control, external amplifier	
Connection type	Subplate, mounting hole configuration NG6 (ISO 4401-03-02-0-94)	
Mounting position	Optional	
Ambient temperature range	°C	-20 ... +50
Weight	kg	2.8
Vibration resistance, test condition	max. 25 g, shaken in 3 dimensions (24 h)	

Hydraulic (measured with HLP 46, $\vartheta_{oil} = 40 \text{ °C} \pm 5 \text{ °C}$)

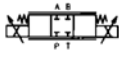
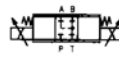
Pressure fluid	Hydraulic oil to DIN 51524 ... 535, other fluids after prior consultation					
Viscosity range	recommended	mm ² /s	20 ... 100			
	max. permitted	mm ² /s	10 ... 800			
Pressure fluid temperature range	°C	-20 ... +80				
Maximum permissible degree of contamination of pressure fluid Purity class to ISO 4406 (c)	Class 18/16/13 ¹⁾					
Direction of flow	See symbol					
Nominal flow at $\Delta p = 5 \text{ bar}$ per notch ²⁾	l/min	6	8	14	16	28
Max. working pressure	bar	Port P, A, B: 315				
Max. pressure	bar	Port T: 250				
Leakage per metering edge ($\Delta p = 100 \text{ bar}$)	$I_m = 0$		A → T = 80 cm ³ /min B → T = 80 cm ³ /min			
Leakage drain ($\Delta p = 5 \text{ bar}$)			A → T = 0.8...1.6 l/min B → T = 0.8...1.6 l/min			

Electrical

Cyclic duration factor	%	100
Power supply	24 V _{nom} (external amplifier)	
Degree of protection	IP 65 to DIN 40050 and IEC 14434/5	
Solenoid connection	Unit plug DIN 43650/ISO 4400, M16 x 1.5 (2P+PE)	
Position transducer connection	Unit plug Pg7 (4P)	
Max. solenoid current	A	2.7
Coil resistance R_{20}	Ω	3
Max. power consumption at 100 % load and operating temperature	VA	40

Static/Dynamic³⁾

Hysteresis	%	≤ 0.3
Range of inversion	%	≤ 0.2
Manufacturing tolerance for Q_{max}	%	≈ 5
Response time 100 % signal change	ms	≈ 30
	10 % signal change	ms

¹⁾ The purity classes stated for the components must be complied with in hydraulic systems. Effective filtration prevents problems and also extends the service life of components. For a selection of filters, see catalog sections RE 50070, RE 50076 and RE 50081.

²⁾ Flow rate at a different Δp $q_x = q_{nom} \cdot \sqrt{\frac{\Delta p_x}{5}}$

³⁾ All specifications achieved in conjunction with proportional amplifier: **0 811 405 119**

Technical data (type 4WRP 10 ..)**General**

Construction	Spool type valve	
Actuation	Proportional solenoid with position control, external amplifier	
Connection type	Subplate, mounting hole configuration NG10 (ISO 4401-05-06-0-94)	
Mounting position	Optional	
Ambient temperature range	°C	-20 ... +50
Weight	kg	8.0
Vibration resistance, test condition	max. 25 g, shaken in 3 dimensions (24 h)	

Hydraulic (measured with HLP 46, $\vartheta_{oil} = 40 \text{ °C} \pm 5 \text{ °C}$)

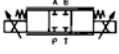
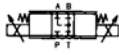
Pressure fluid	Hydraulic oil to DIN 51524 ... 535, other fluids after prior consultation		
Viscosity range	recommended	mm ² /s	20 ... 100
	max. permitted	mm ² /s	10 ... 800
Pressure fluid temperature range	°C	-20 ... +80	
Maximum permissible degree of contamination of pressure fluid Purity class to ISO 4406 (c)	Class 18/16/13 ¹⁾		
Direction of flow	See symbol		
Nominal flow at $\Delta p = 5 \text{ bar}$ per notch ²⁾	l/min	32	63
Max. working pressure	bar	Port P, A, B: 315	
Max. pressure	bar	Port T: 250	
	bar	Port L: 2	
Leakage per metering edge ($\Delta p = 100 \text{ bar}$)	$I_m = 0$		A → T = 80 cm ³ /min B → T = 80 cm ³ /min
Leakage drain ($\Delta p = 5 \text{ bar}$)			A → T = 0.4...0.8 l/min B → T = 0.4...0.8 l/min

Electrical

Cyclic duration factor	%	100
Power supply	24 V _{nom} (external amplifier)	
Degree of protection	IP 65 to DIN 40050 and IEC 14434/5	
Solenoid connection	Unit plug DIN 43650/ISO 4400, M16 x 1.5 (2P+PE)	
Position transducer connection	Unit plug Pg7 (4P)	
Max. solenoid current	A	3.7
Coil resistance R_{20}	Ω	2.5
Max. power consumption at 100 % load and operating temperature	VA	60

Static/Dynamic³⁾

Hysteresis	%	≤ 0.75	
Range of inversion	%	≤ 0.5	
Manufacturing tolerance for Q_{max}	%	≈ 10	
Response time	100 % signal change	ms	≈ 50
	10 % signal change	ms	≈ 20

¹⁾ The purity classes stated for the components must be complied with in hydraulic systems. Effective filtration prevents problems and also extends the service life of components. For a selection of filters, see catalog sections RE 50070, RE 50076 and RE 50081.

²⁾ Flow rate at a different Δp $q_x = q_{nom} \cdot \sqrt{\frac{\Delta p_x}{5}}$

³⁾ All specifications achieved in conjunction with proportional amplifier: **0 811 405 120**

Valve with external trigger electronics (standard with ramps, RE 30048)

Circuit diagram/pin assignment

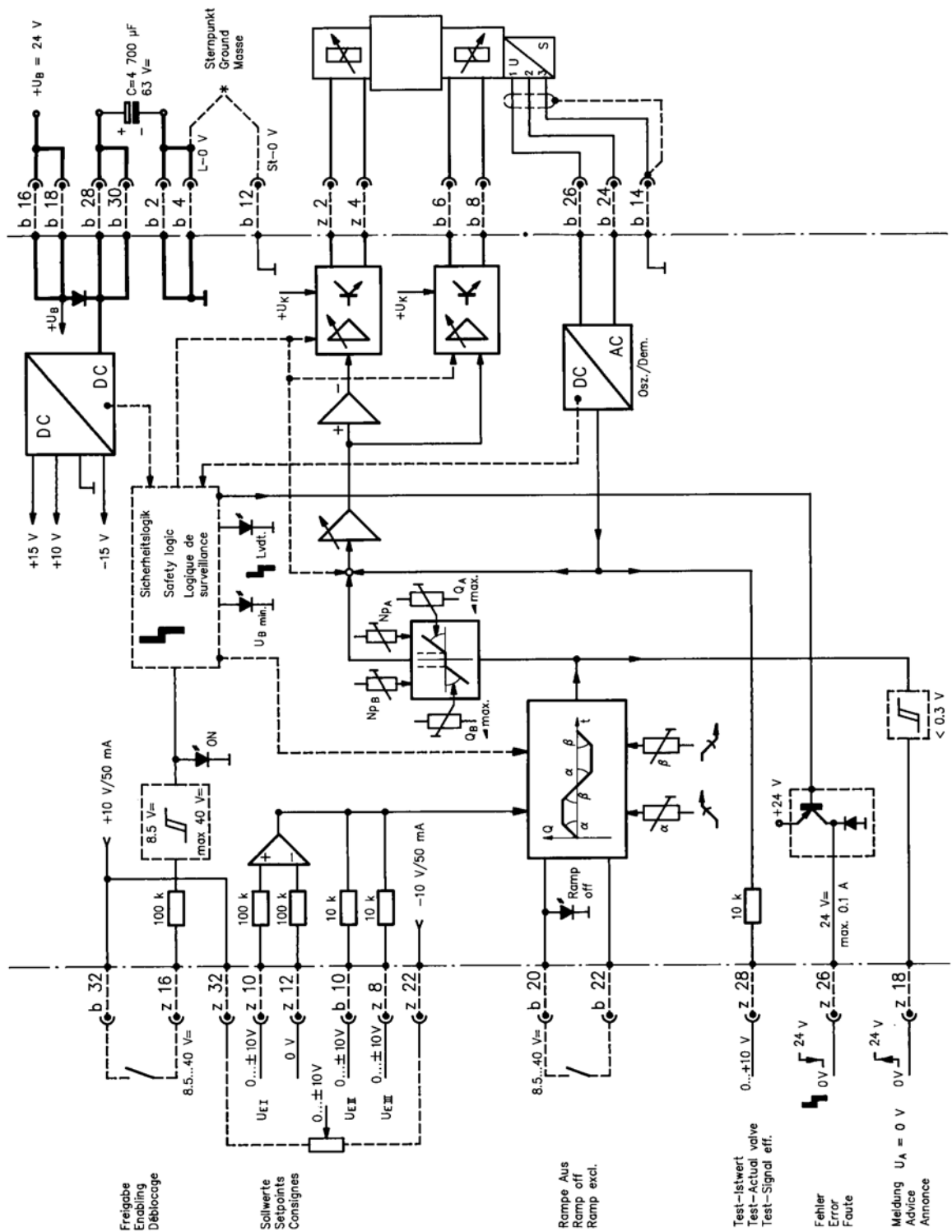

Versions of trigger electronics:
 - With voltage-controlled ramps,
 see page 8 and RE 30047

Valve with external trigger electronics (with voltage-controlled ramps, RE 30047)

Circuit diagram/pin assignment

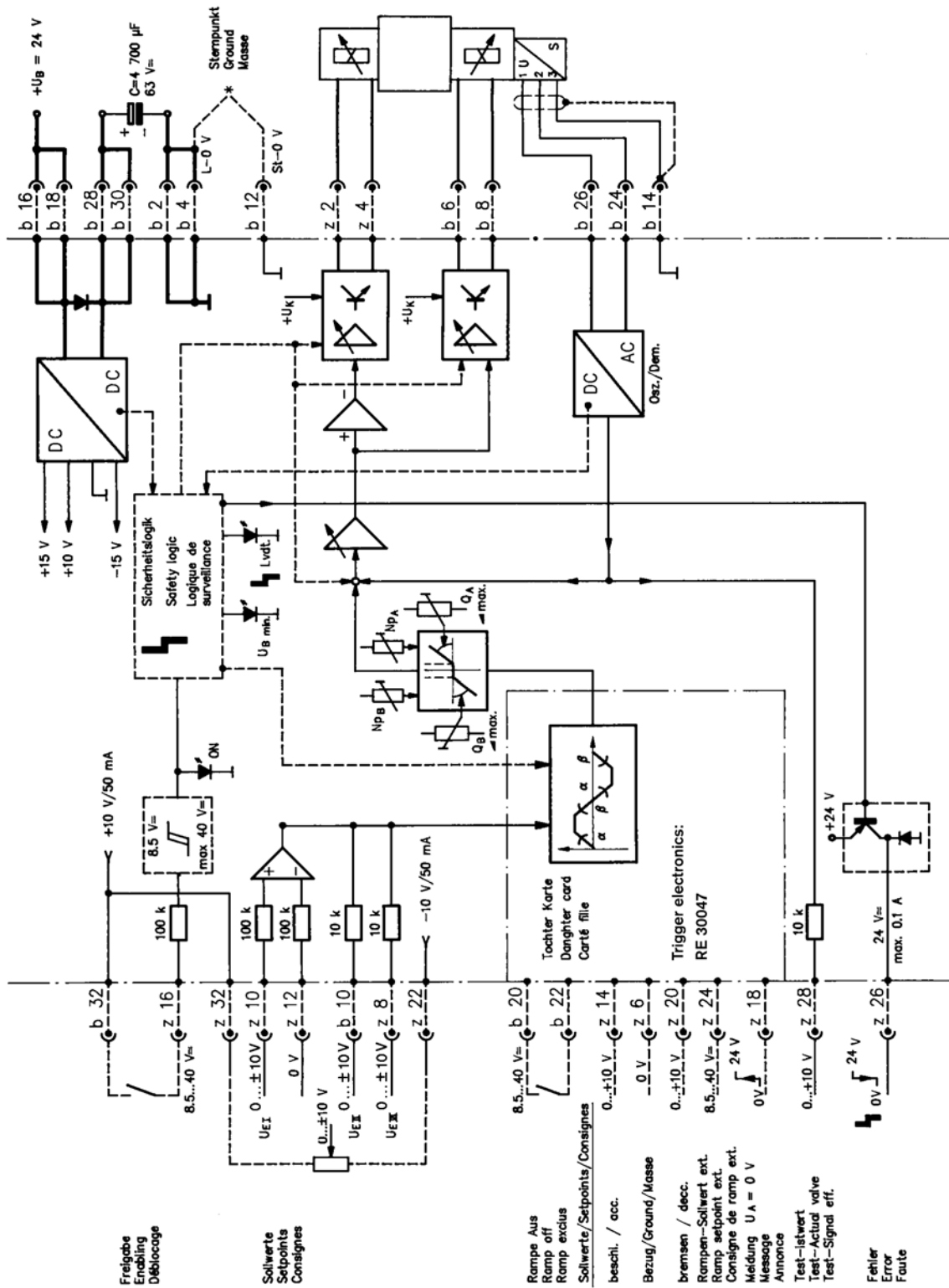

Versions of trigger electronics:
 - With ramps, see page 7 and RE 30048

Characteristic curves type 4WRP 6 E.. / W.. (measured with HLP 46, $\vartheta_{oil} = 40 \text{ }^\circ\text{C} \pm 5 \text{ }^\circ\text{C}$)

Flow rate/Signal function (at $\Delta p = 5 \text{ bar}$ per notch)

$Q_{nom} = 5.8/8 \text{ l/min}$

— $Q_N = 8 \text{ l/min}$
 - - - $Q_N = 5.8 \text{ l/min}$

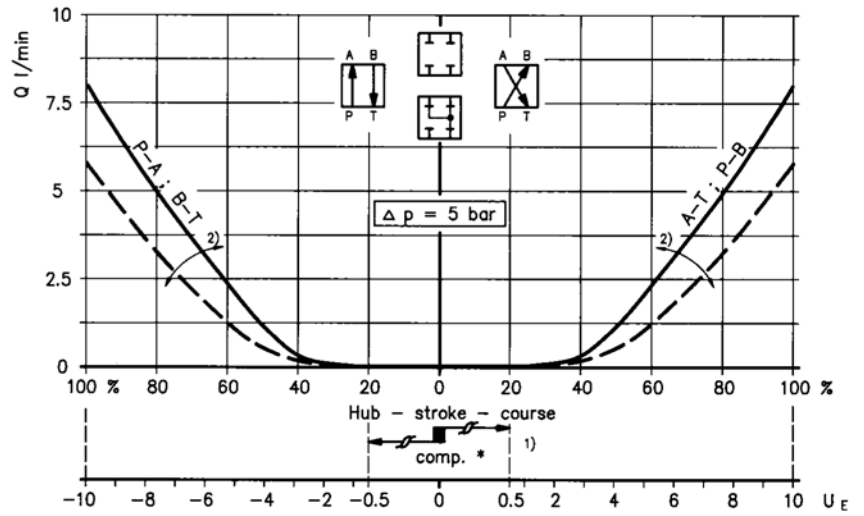

$Q_{nom} = 14/16 \text{ l/min}$

— $Q_N = 16 \text{ l/min}$
 - - - $Q_N = 14 \text{ l/min}$

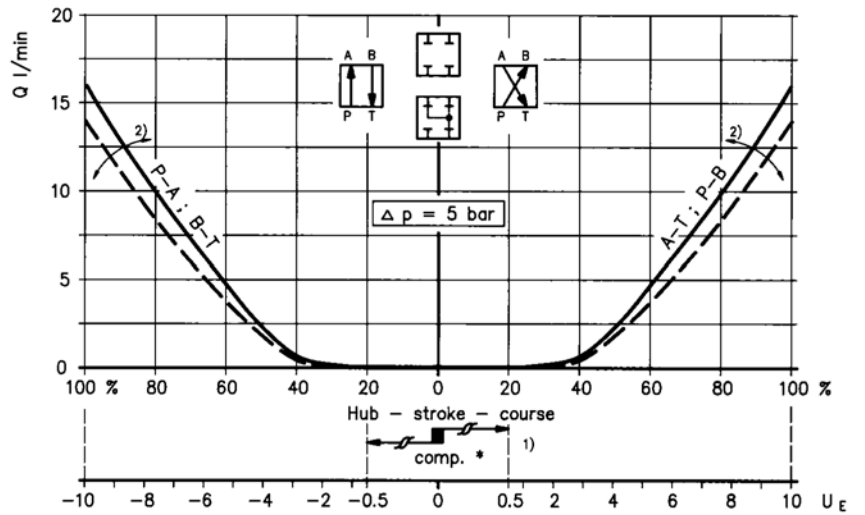

$Q_{nom} = 28 \text{ l/min}$

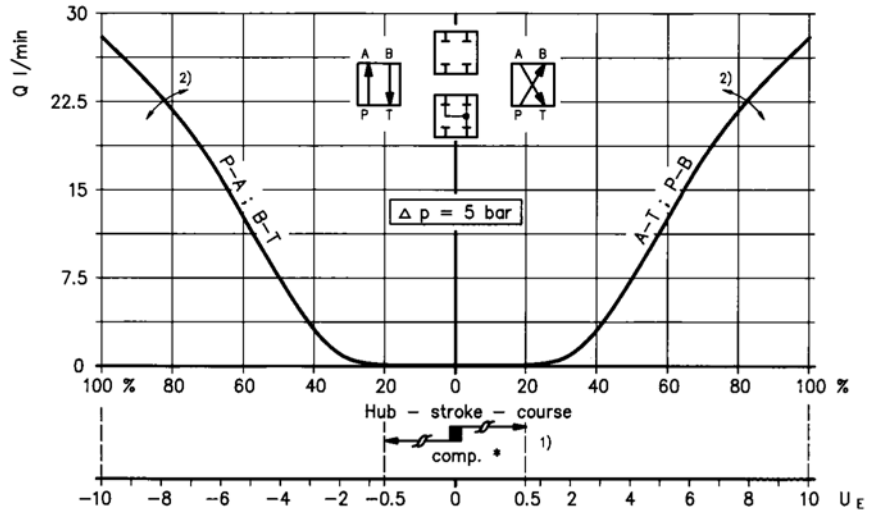

Valve amplifier

- 1) Zero adjustment $\rightarrow \pm 0.5 \text{ V}$
- 2) Sensitivity adjustment

Characteristic curves type 4WRP 10 E .. / W.. (measured with HLP 46, $\vartheta_{oil} = 40 \text{ }^\circ\text{C} \pm 5 \text{ }^\circ\text{C}$)

Flow rate/Signal function (at $\Delta p = 5 \text{ bar}$ per notch)

$Q_{nom} = 32 \text{ l/min}$

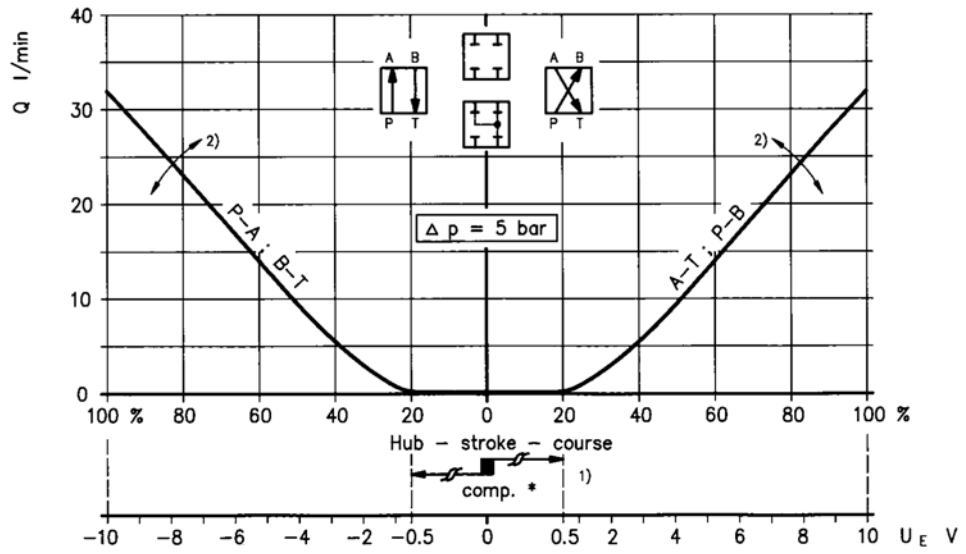

$Q_{nom} = 63 \text{ l/min}$

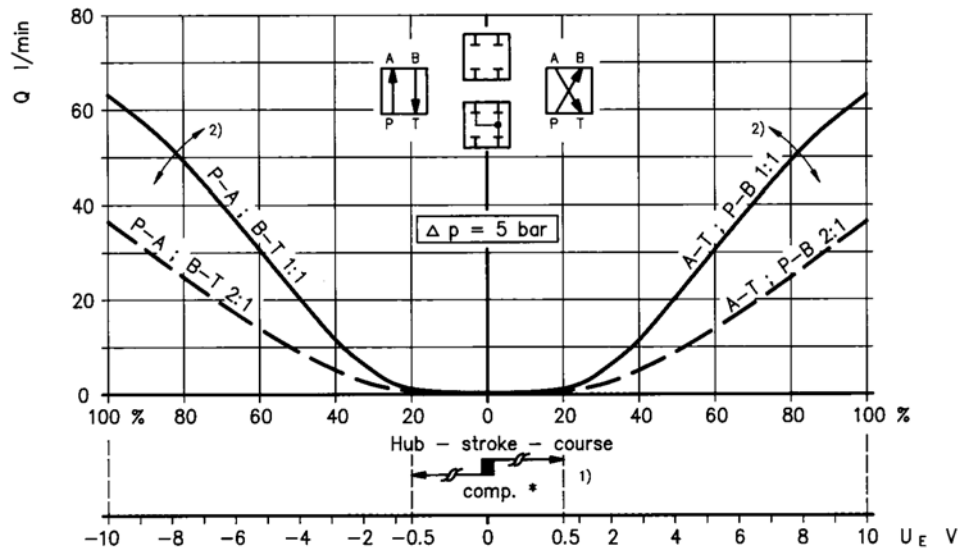

Valve amplifier

- 1) Zero adjustment $\rightarrow \pm 0.5 \text{ V}$
- 2) Sensitivity adjustment

Operating limits (measured with HLP 46, $\vartheta_{oil} = 40 \text{ °C} \pm 5 \text{ °C}$)

Type 4WRP 6 E.. / W..

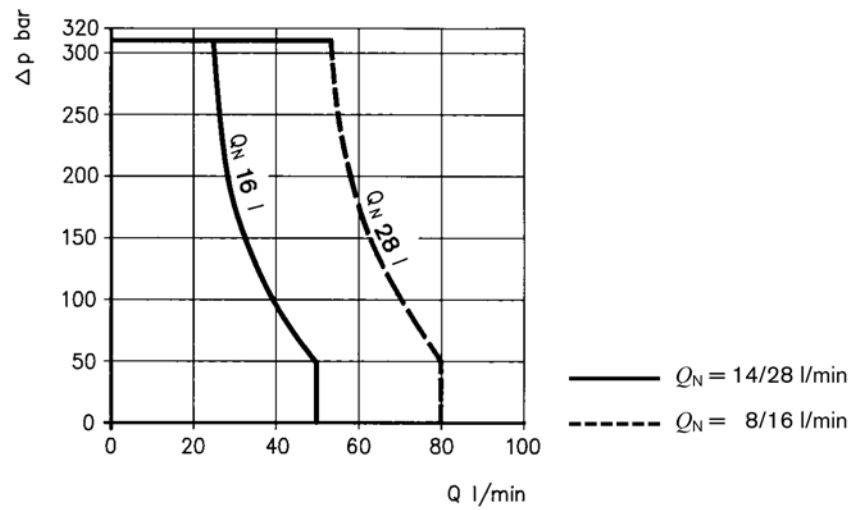

Type 4WRP 10 E.. / W..

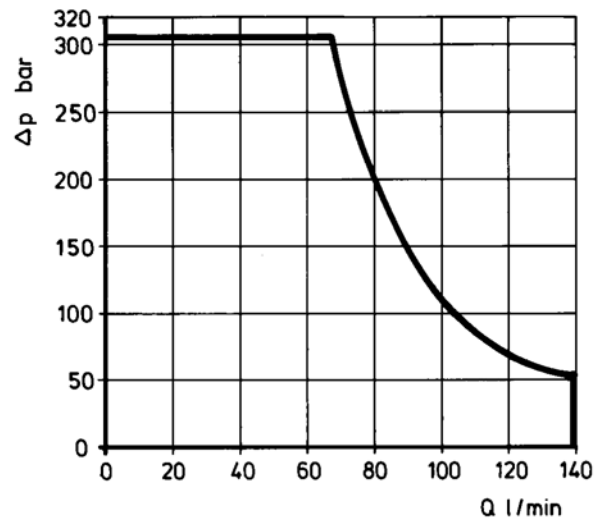

Unit dimensions type 4WRP 6 E.. / W.. (nominal dimensions in mm)

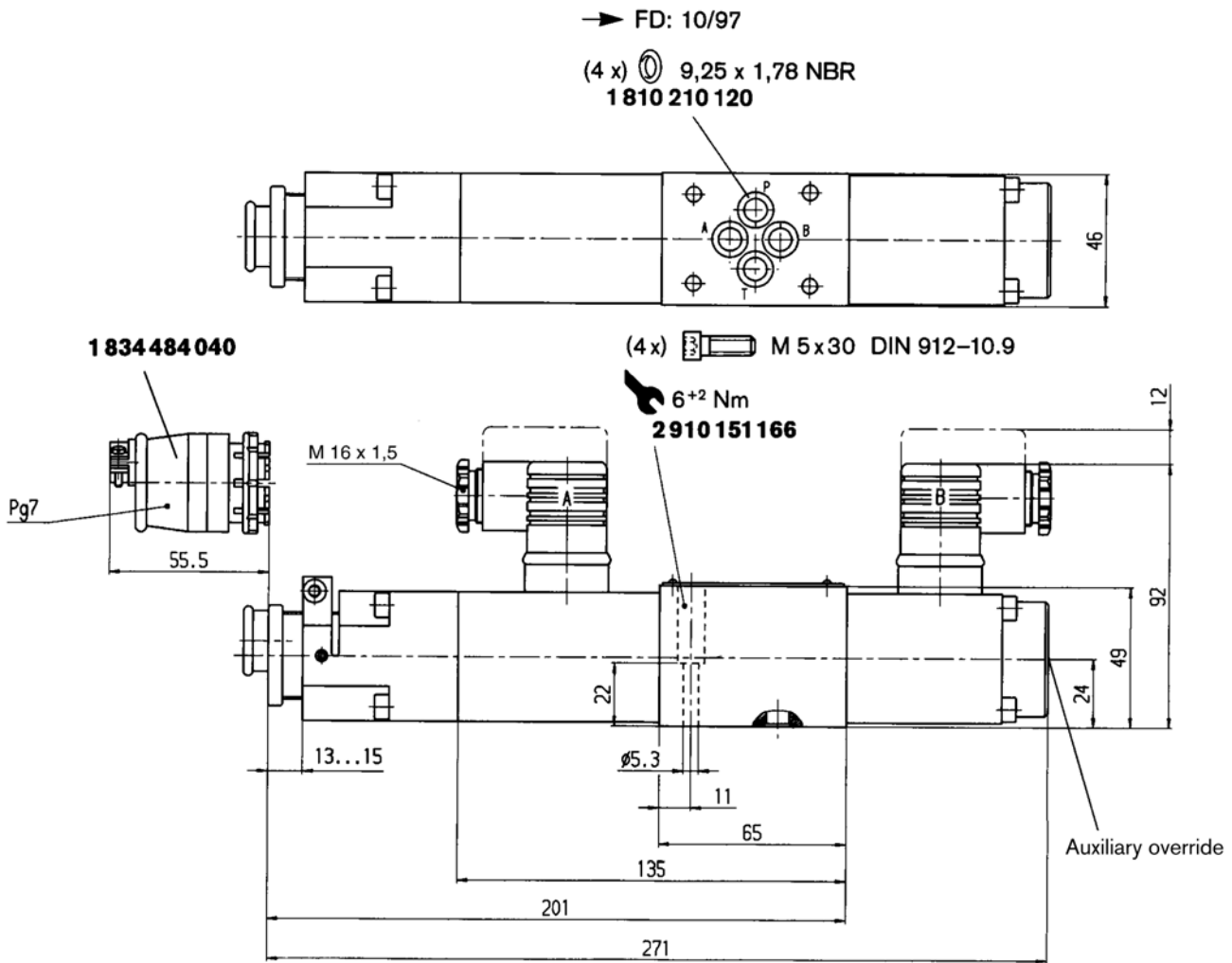

Required surface quality of mating component

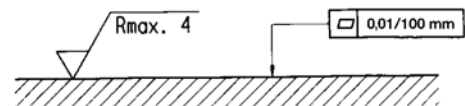

Mounting hole configuration: NG6 (ISO 4401-03-02-0-94)
 For subplates see catalog section RE 45053

- 1) Deviates from standard
- 2) Thread depth:
 Ferrous metal 1.5 x $\text{\textcircled{O}}$
 Non-ferrous 2 x $\text{\textcircled{O}}$

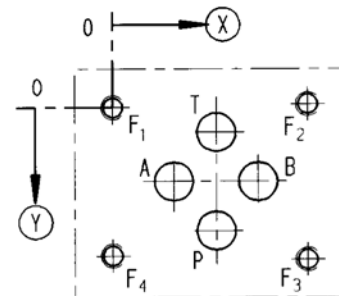

	P	A	T	B	F ₁	F ₂	F ₃	F ₄
$\text{\textcircled{X}}$	21.5	12.5	21.5	30.2	0	40.5	40.5	0
$\text{\textcircled{Y}}$	25.9	15.5	5.1	15.5	0	-0.75	31.75	31
$\text{\textcircled{O}}$	8 ¹⁾	8 ¹⁾	8 ¹⁾	8 ¹⁾	M5 ²⁾	M5 ²⁾	M5 ²⁾	M5 ²⁾

Unit dimensions type 4WRP 10 E .. / W.. (nominal dimensions in mm)

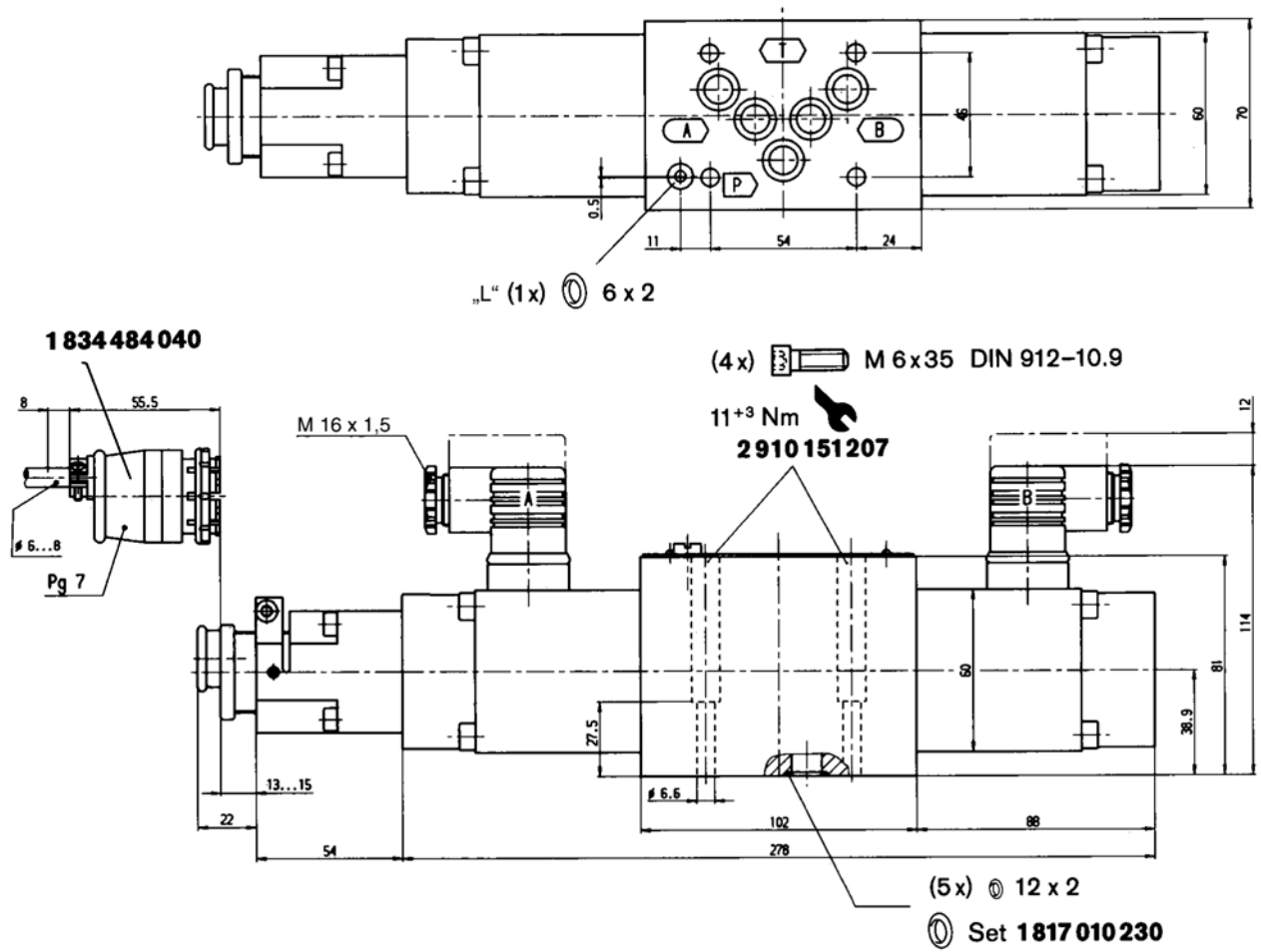

Required surface quality of mating component

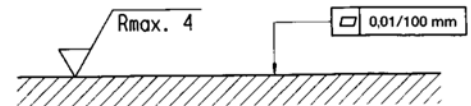

Mounting hole configuration: NG10 (ISO 4401-05-06-0-94)
For subplates see catalog section RE 45055

- 1) Deviates from standard
- 2) Thread depth:
Ferrous metal $1.5 \times \varnothing^*$
Non-ferrous $2 \times \varnothing$
- * (NG10 min. 10.5 mm)

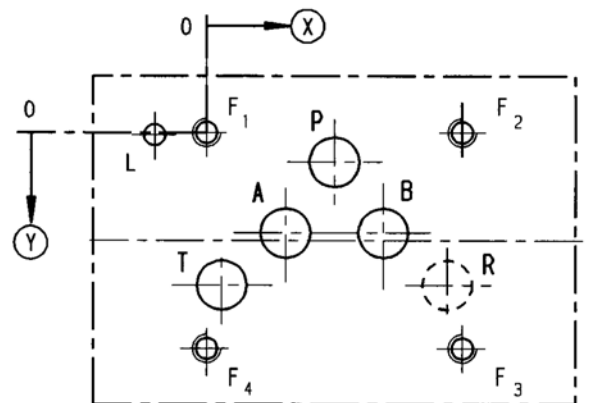

	P	A	T	B	F ₁	F ₂	F ₃	F ₄	R	L
⊗	27	16.7	3.2	37.3	0	54	54	0	50.8	-11
⊙	6.3	21.4	32.5	21.4	0	0	46	46	32.5	0.5
∅	10.5 ¹⁾	10.5 ¹⁾	10.5 ¹⁾	10.5 ¹⁾	M6 ²⁾	M6 ²⁾	M6 ²⁾	M6 ²⁾	10.5 ¹⁾	4.5