

## Basic Pump

C

## Self Priming Centrifugal Pump

**Super  
T SERIES**  
VARIOUS PATENTS APPLY

Model T6A60S-B

Size 6" x 6"



## PUMP SPECIFICATIONS

**Size:** 6" x 6" (152 mm x 152 mm) NPT - Female.

**Pump Casing:** Gray Iron 30.

Maximum Operating Pressure 79 psi (545 kPa).\*

**Semi-Open Type, Two Vane Impeller:** Ductile Iron 65-45-12.

Handles 3" (76,2 mm) Diameter Spherical Solids.

**Impeller Shaft:** Alloy Steel 4150.

**Shaft Sleeve:** Alloy Steel 4130.

**Replaceable Wear Plate:** Carbon Steel 1026.

**Removable Adjustable Cover Plate:** Gray Iron 30; 62 lbs. (28 kg).

**Flap Valve:** Neoprene w/Nylon and Steel Reinforcing.

**Seal Plate:** Gray Iron 30.

**Bearing Housing:** Gray Iron 30.

**Radial Bearing:** Open Single Row Ball.

**Thrust Bearing:** Open Double Row Ball.

**Bearing and Seal Cavity Lubrication:** SAE 30 Non-Detergent Oil.

**Flanges:** Gray Iron 30.

**Gaskets:** Buna-N, Compressed Synthetic Fibers, PTFE, Vegetable Fiber, Cork, and Rubber.

**O-Rings:** Buna-N.

**Hardware:** Standard Plated Steel.

**Brass Pressure Relief Valve.**

**Bearing and Seal Cavity Oil Level Sight Gauges.**

**Optional Equipment:** Metal Bellows Seal. Automatic Air

Release Valve. 120V/240V Casing Heater. High Pump

Temperature Shutdown Kit. G-R Hard Iron Casing.

Self-Cleaning Wear Plate.

Gray Iron 30 Suction and Discharge Spool Flanges:

6" ASA (**Specify Model T6A60S-B /F**).

150 mm DIN 2527 (PN16) (**Specify Model T6A60S-B /FM**).

\*Consult Factory for Applications Exceeding Maximum Pressure and/or Temperature Indicated.



Shown with Optional Suction & Discharge Spool Flanges (Available in ASA or DIN Standard Sizes).

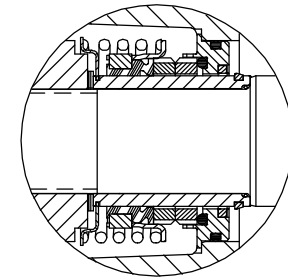
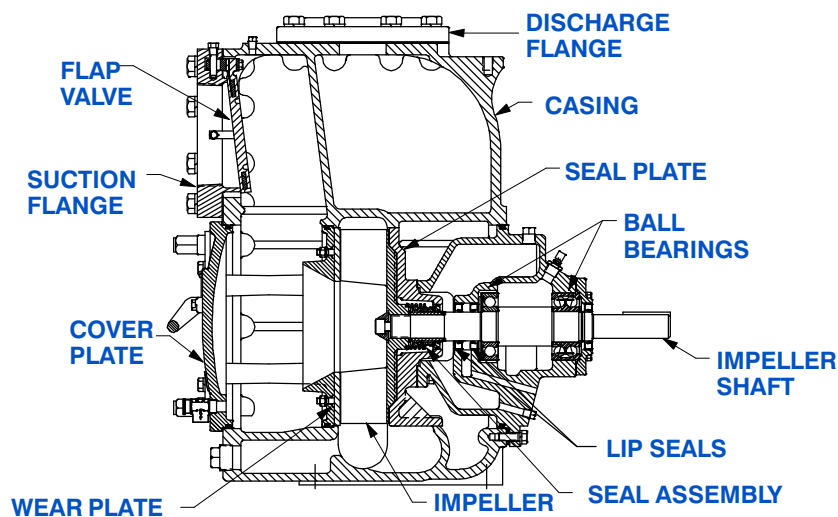

## SEAL DETAIL

Cartridge Type, Mechanical, Oil-Lubricated, Double Floating, Self-Aligning. Silicon Carbide Rotating and Stationary Faces. Stainless Steel 316 Stationary Seat. Fluorocarbon Elastomers (DuPont Viton® or Equivalent). Stainless Steel 18-8 Cage and Spring. Maximum Temperature of Liquid Pumped, 160°F (71°C).\*



THE GORMAN-RUPP COMPANY • MANSFIELD, OHIO

GORMAN-RUPP OF CANADA LIMITED • ST. THOMAS, ONTARIO, CANADA

www.grpumps.com

Specifications Subject to Change Without Notice

Printed in U.S.A.

**Specification Data**

**APPROXIMATE DIMENSIONS and WEIGHTS**

**NET WEIGHT: 855 LBS. (388 KG.)\***  
**SHIPPING WEIGHT: 910 LBS. (413 KG.)\***  
**EXPORT CRATE: 32.5 CU. FT. (0.92 CU. M.)**  
**\*ADD 25 LBS. (11,3 KG.) W/EACH SPOOL FLANGE**

SECTION 55, PAGE 2210

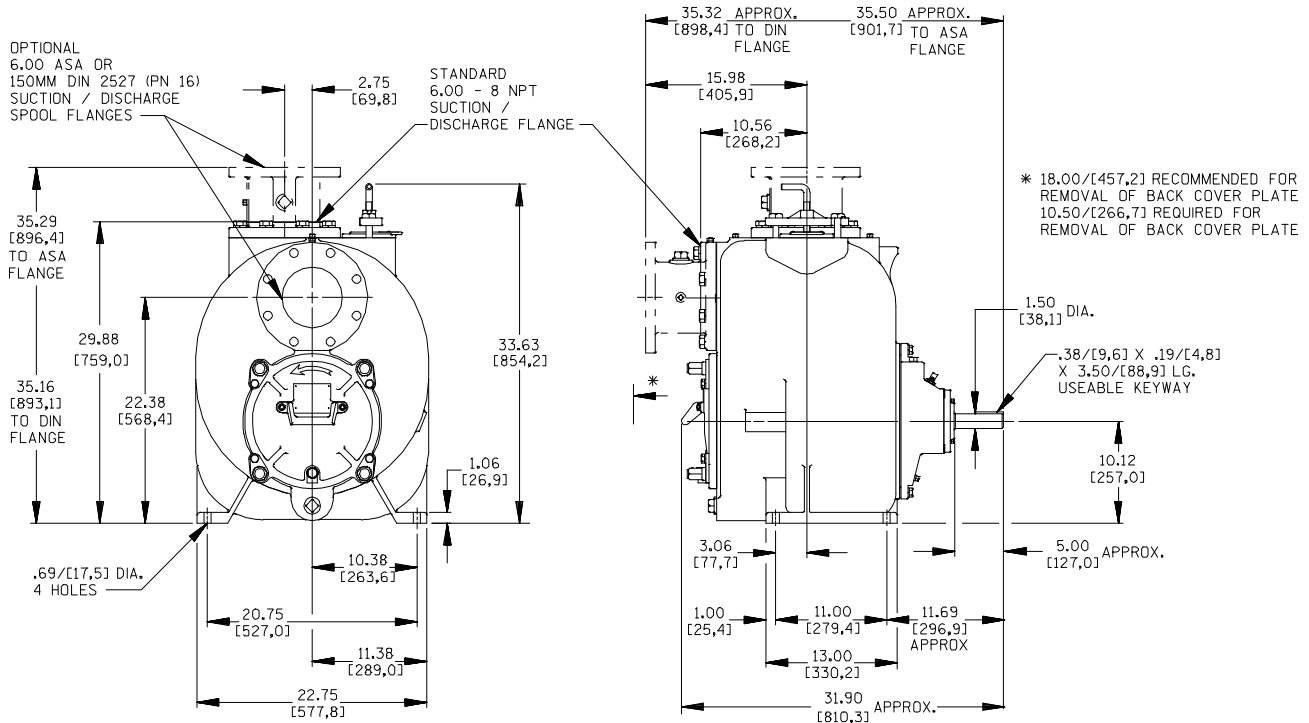

**OPTIONAL ASA OR DIN STANDARD SUCTION & DISCHARGE SPOOL FLANGES AVAILABLE**

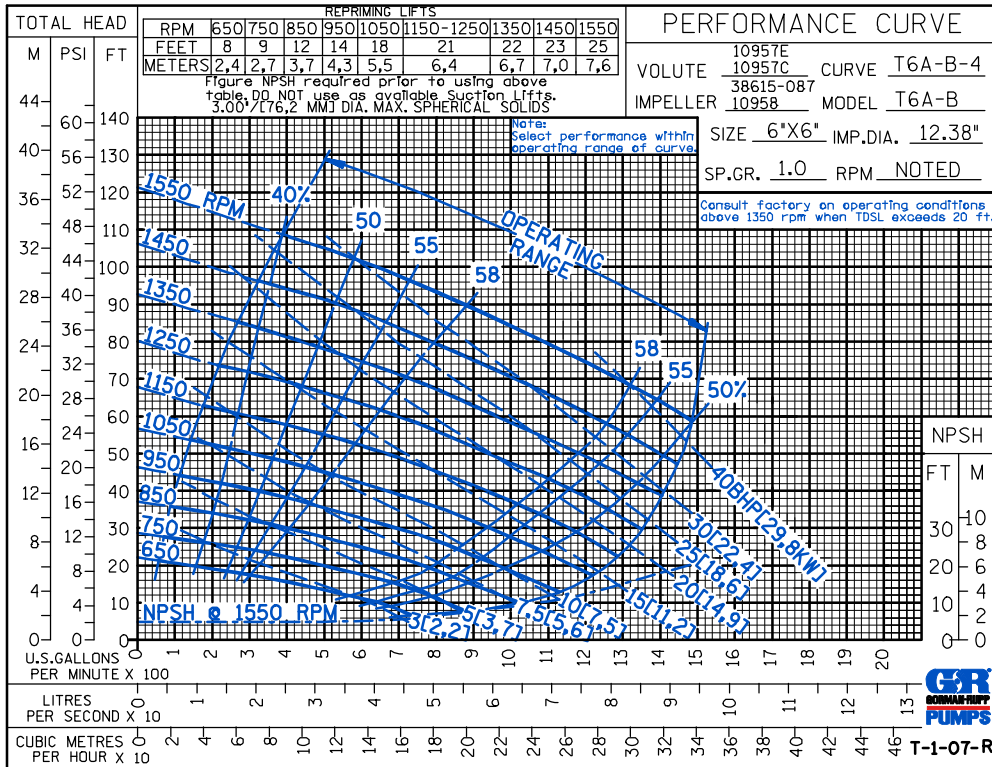

**THE GORMAN-RUPP COMPANY • MANSFIELD, OHIO**

GORMAN-RUPP OF CANADA LIMITED • ST. THOMAS, ONTARIO, CANADA

Specifications Subject to Change Without Notice

Printed in U.S.A.

CDS

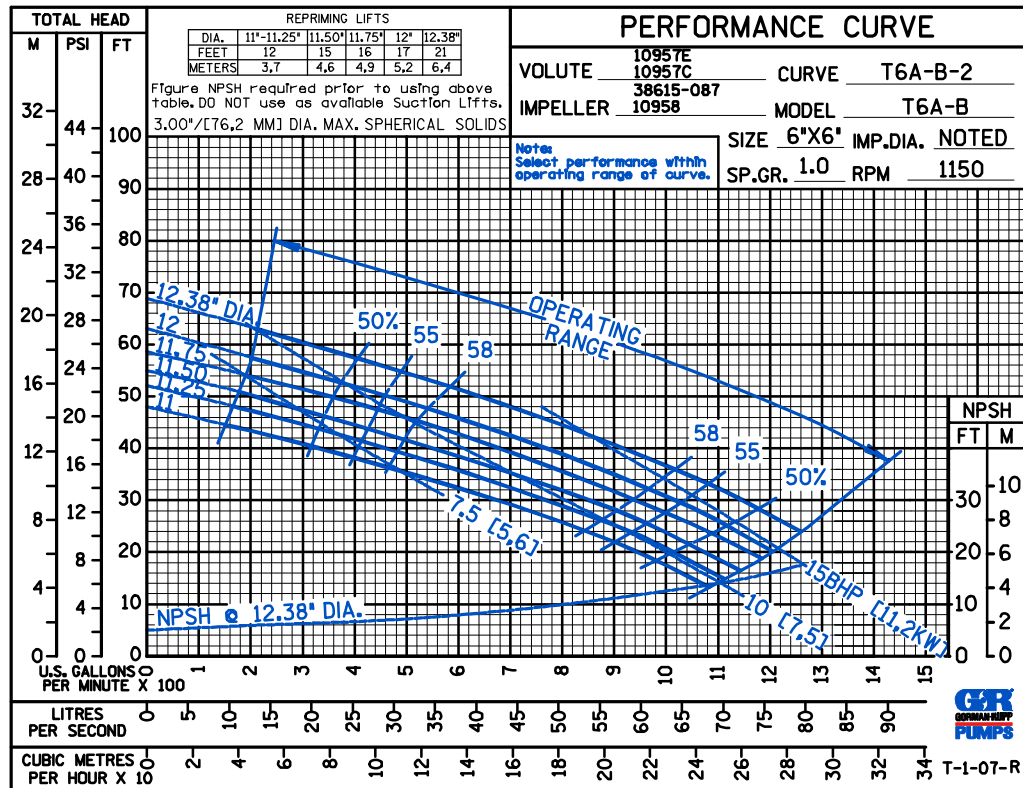
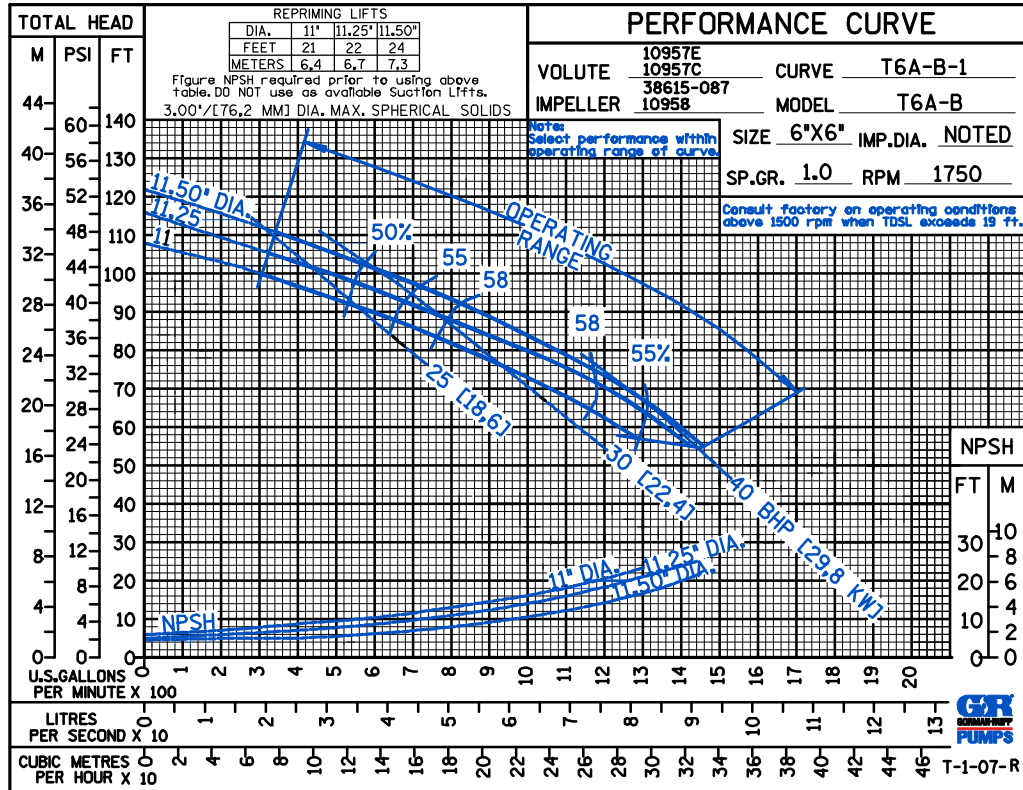

THE GORMAN-RUPP COMPANY • MANSFIELD, OHIO

GORMAN-RUPP OF CANADA LIMITED • ST. THOMAS, ONTARIO, CANADA

Specifications Subject to Change Without Notice

Printed in U.S.A.

CDS

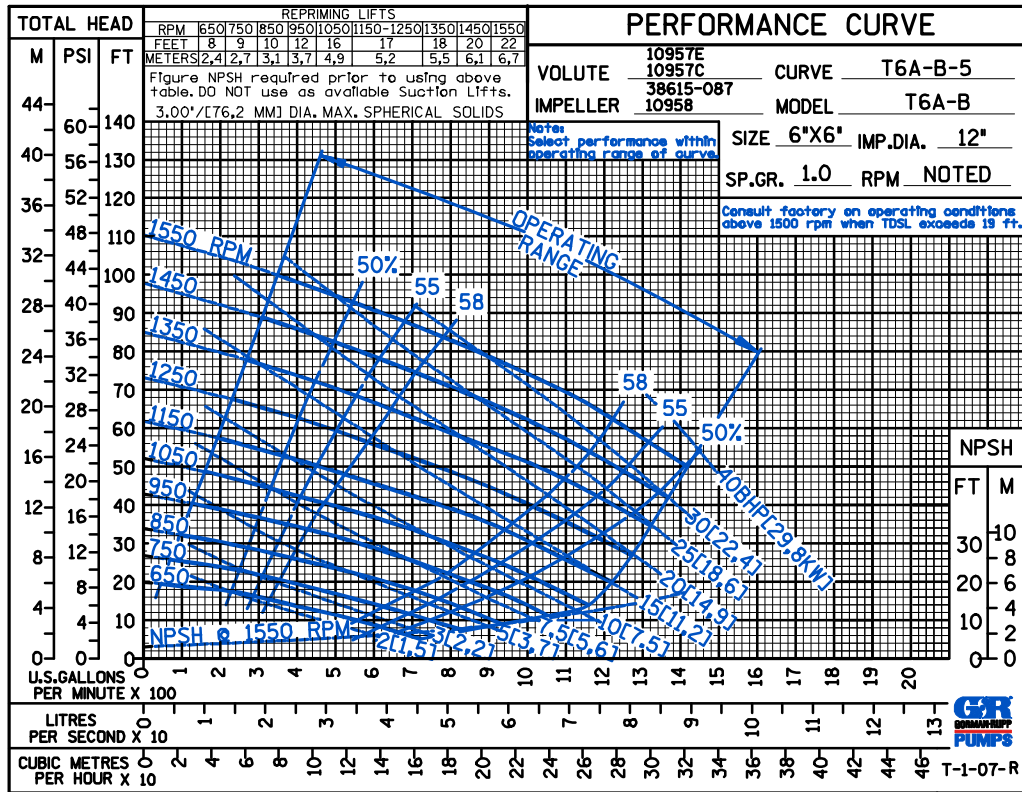
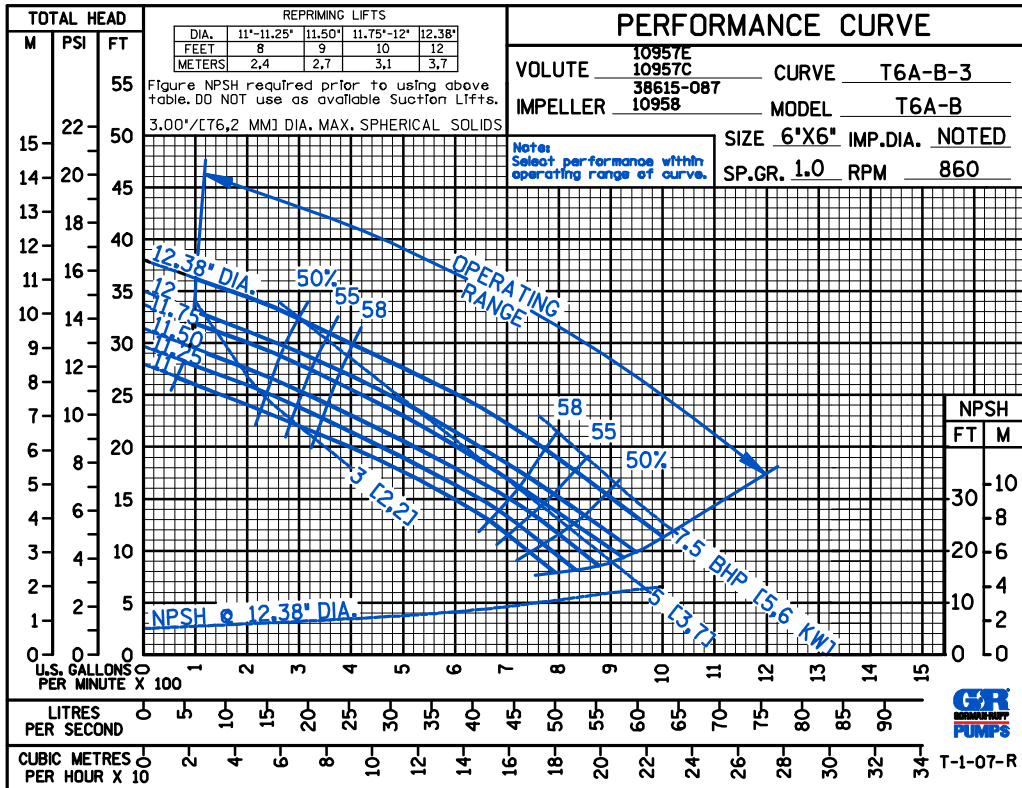

THE GORMAN-RUPP COMPANY • MANSFIELD, OHIO

GORMAN-RUPP OF CANADA LIMITED • ST. THOMAS, ONTARIO, CANADA

Specifications Subject to Change Without Notice

Printed in U.S.A.

CDS

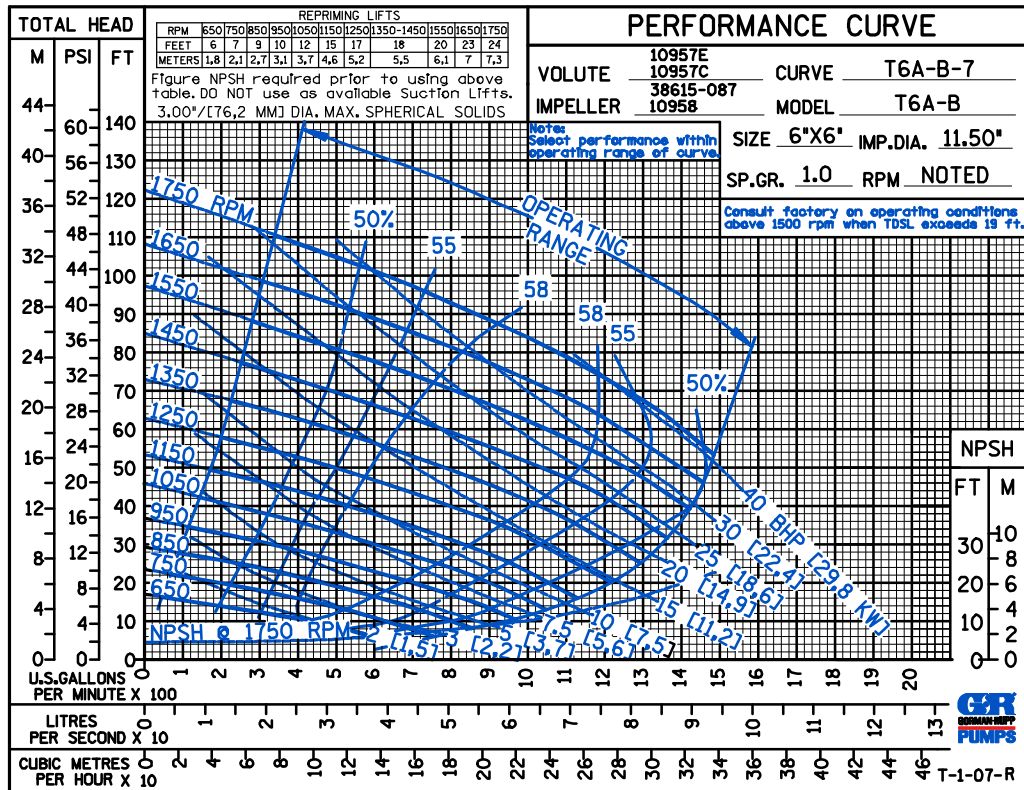
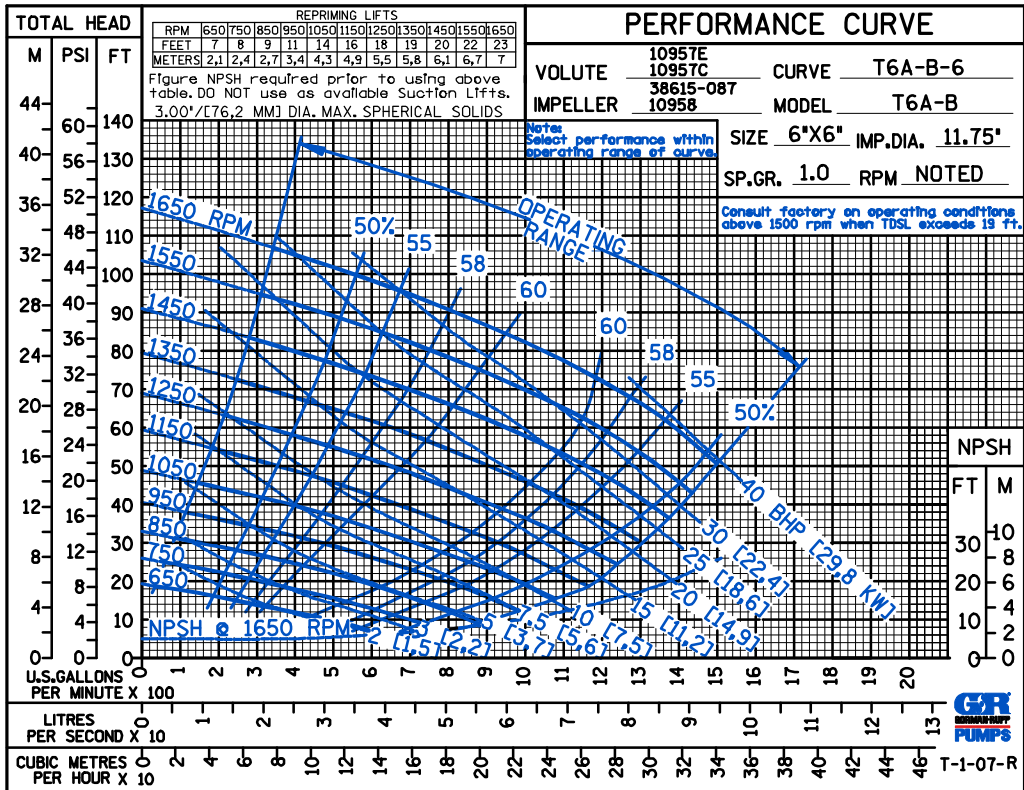

THE GORMAN-RUPP COMPANY • MANSFIELD, OHIO

GORMAN-RUPP OF CANADA LIMITED • ST. THOMAS, ONTARIO, CANADA

Specifications Subject to Change Without Notice

Printed in U.S.A.

CDS

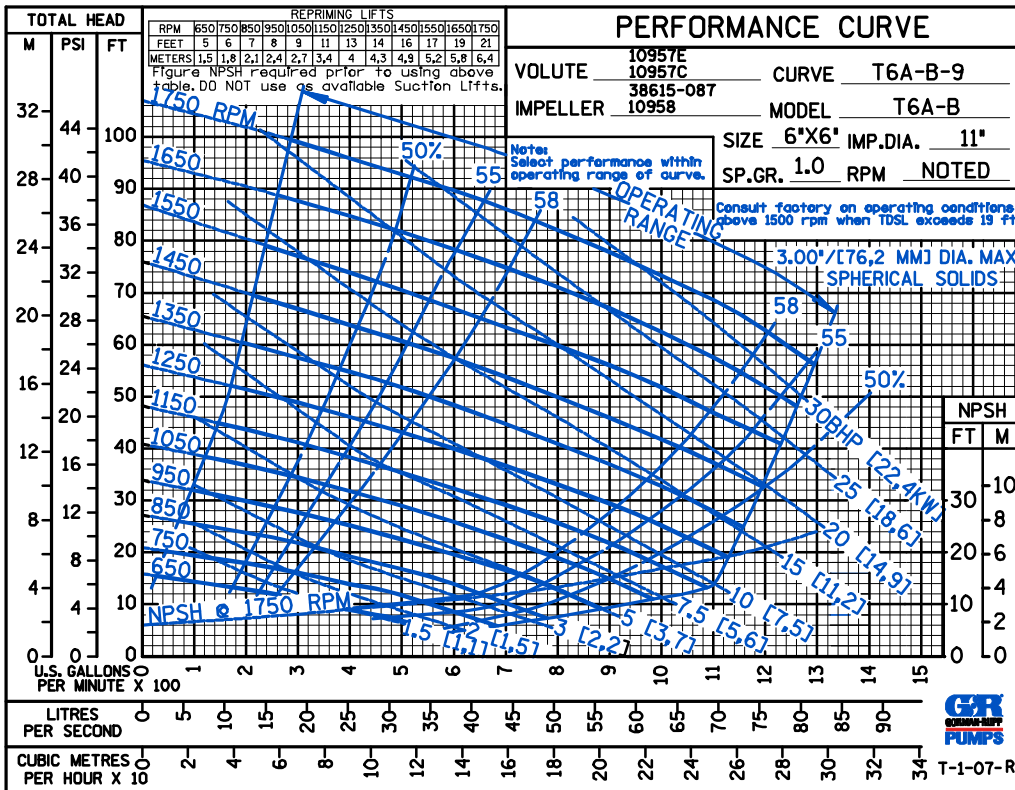
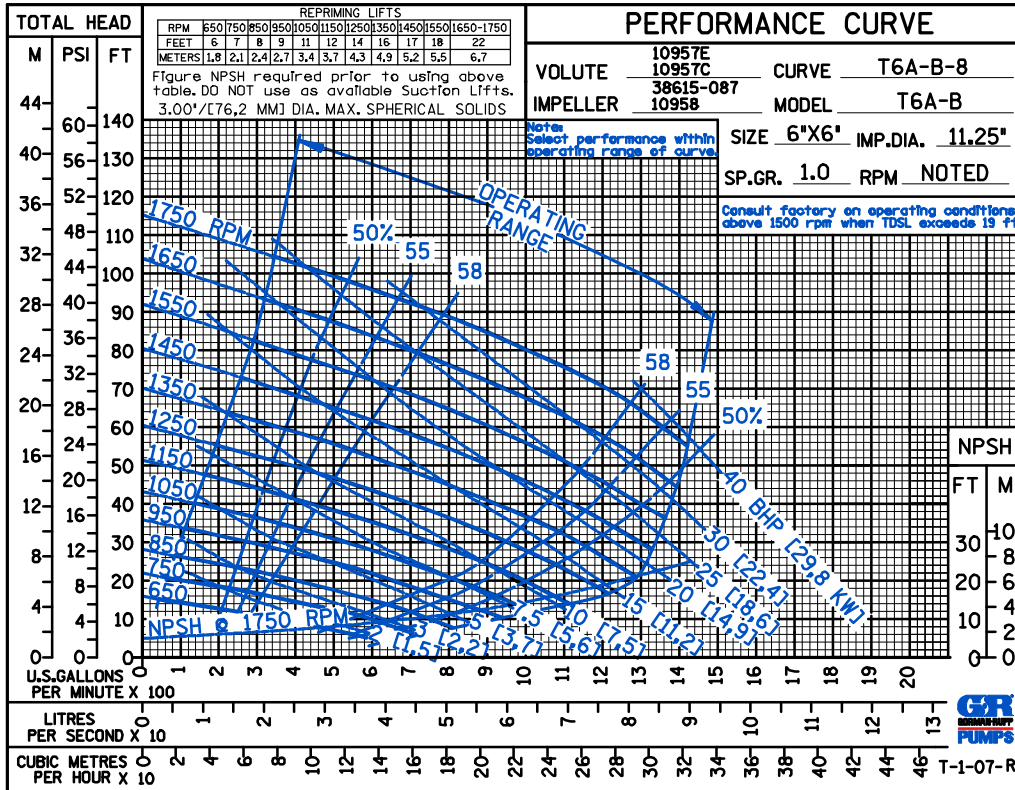

THE GORMAN-RUPP COMPANY • MANSFIELD, OHIO

GORMAN-RUPP OF CANADA LIMITED • ST. THOMAS, ONTARIO, CANADA

Specifications Subject to Change Without Notice

Printed in U.S.A.

CDS

50 HERTZ

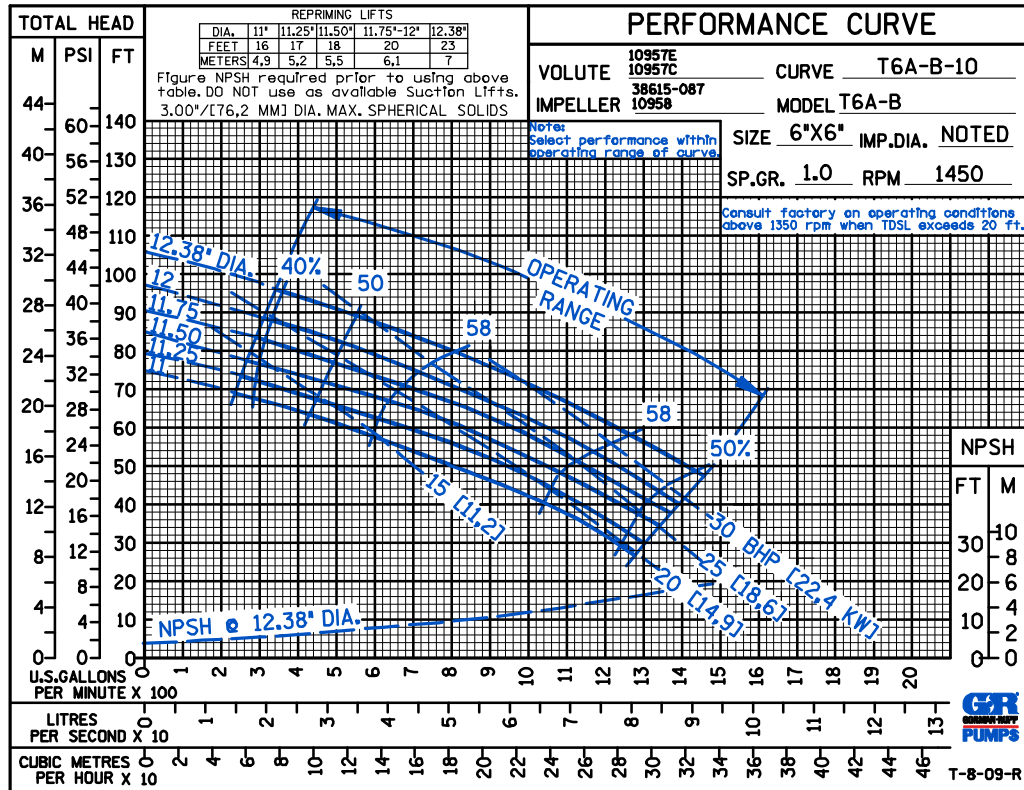

50 HERTZ

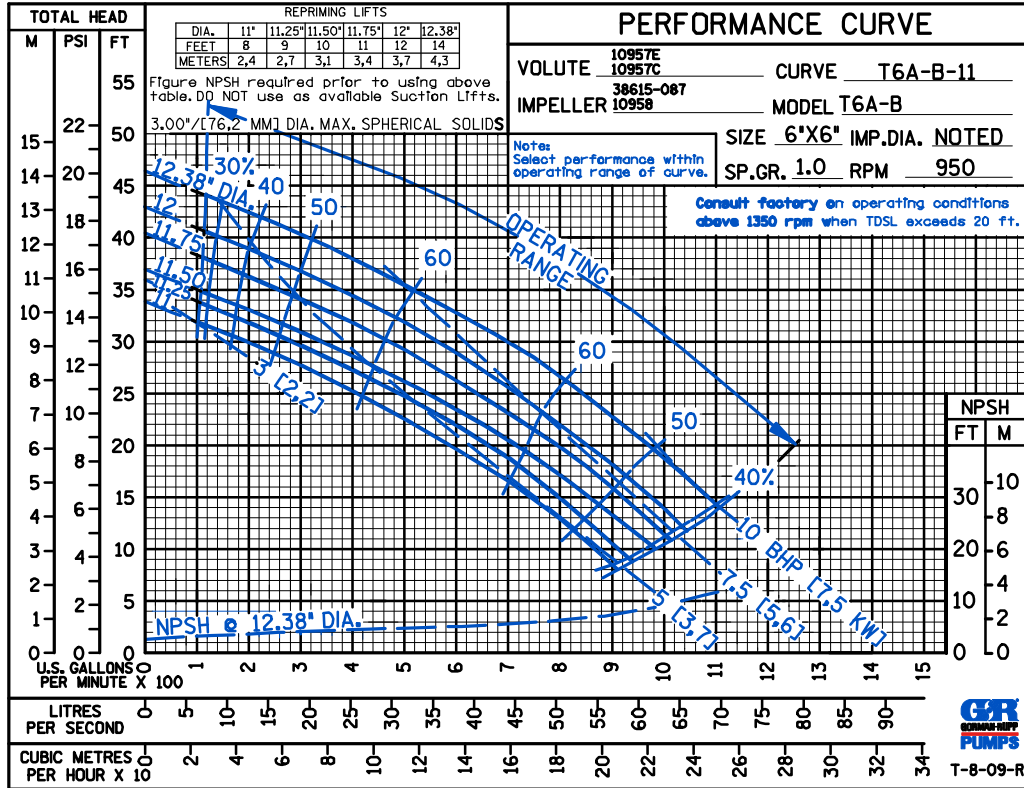

THE GORMAN-RUPP COMPANY • MANSFIELD, OHIO

GORMAN-RUPP OF CANADA LIMITED • ST. THOMAS, ONTARIO, CANADA

Specifications Subject to Change Without Notice

Printed in U.S.A.

D S

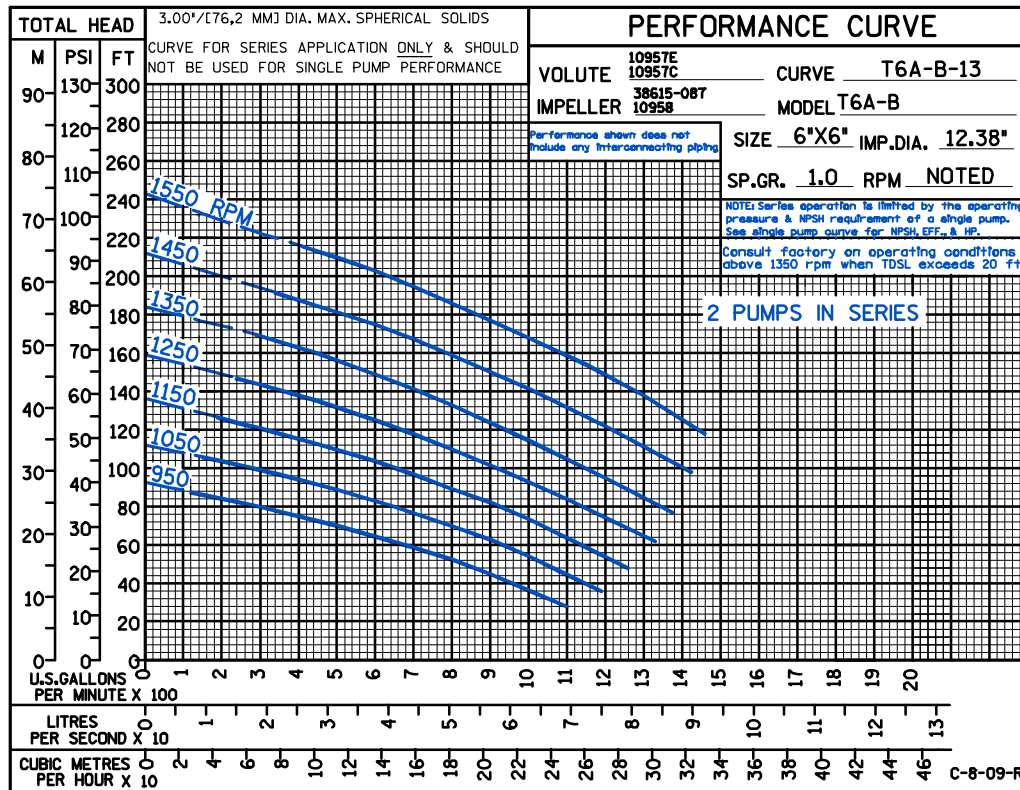
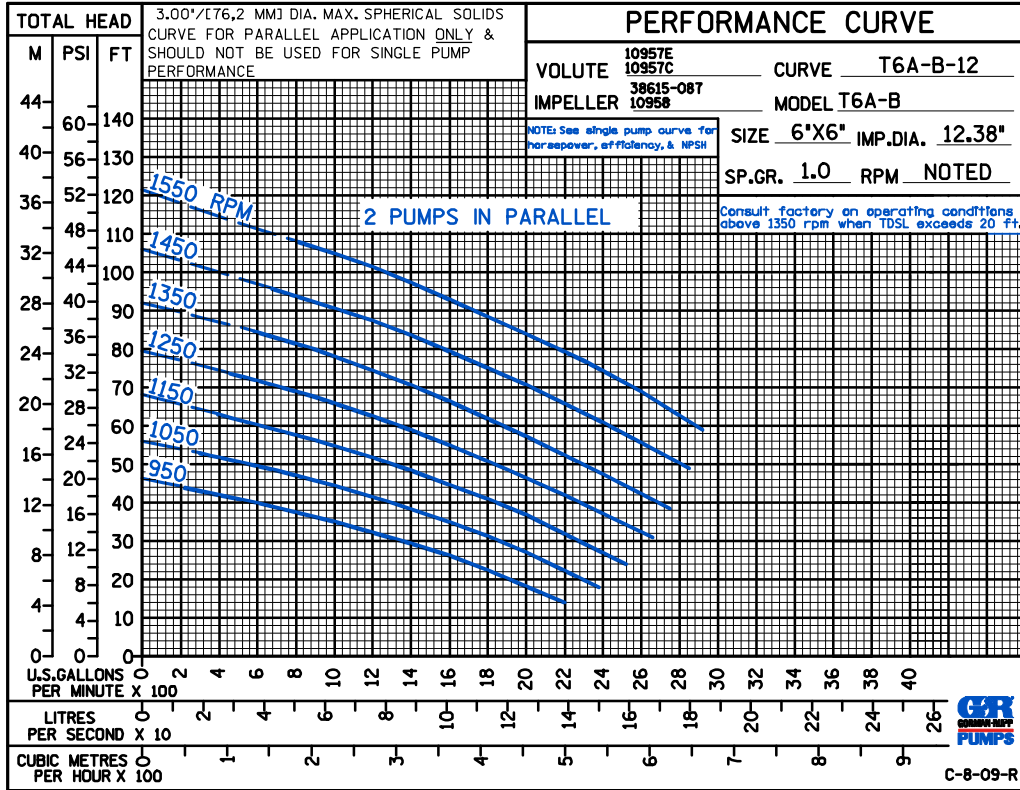

THE GORMAN-RUPP COMPANY • MANSFIELD, OHIO

GORMAN-RUPP OF CANADA LIMITED • ST. THOMAS, ONTARIO, CANADA

Specifications Subject to Change Without Notice

Printed in U.S.A.