

Microswitch



YBLXW-6/11 Microswitch

1. General

YBLXW-6 series microswitches apply to the control circuit, whose alternating current are 50~60Hz, AC380V, Ie0.79A; DC220V, Ie0.14A. They are widely applied to the travel control, spacing protection and change the use of circuit component of all kinds of machinery equipments, which are machinery, spinning, light industry, electronic instrument and so on. The normal operation of products are on altitude, which is not exceeding 2000m, environment temperature is -5°C~+40°C; humidity is 85%(20°C); operation frequency is 40 times every minute, level of protection is IP52.

Up to standard: GB 14048.5, IEC 60947-5-1, acquired CCC national compulsory product certification.

2. Type designation

YB LX W-6 /1 1 □

- YB Improved product
- LX Travel switch
- W Inching
- 6 Design sequence No.
- /1 A pair of normally opened contact
- 1 A pair of normally closed contact
- Operating mode

Contact type

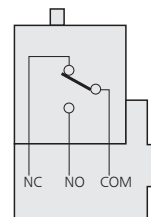

3. Technical data

Level of protection	IP52
Nominal voltage	AC 380V DC 220V
Nominal current	AC 0.79A DC 0.14A
Mechanical life	60×10 ⁴ times
Electrical life	30×10 ⁴ times
Operation frequency	40 t/min
Operating speed	0.1mm/s~0.5mm/s
Environment temperature	-5°C~+40°C
Related humidity	≤85%(20°C)
Altitude	≤2000m
Withstand voltage	Between homopolar terminals(AC 1140V)
	Between electrified metal pieces and ground(AC 1890V)
	Between terminal and non-electrified metal pieces (2500V)
Scope of application	Machine tool, mechanical automatic control, constrained motion, transmission mechanism movement or process contro
Up to standard	GB 14048.5 , IEC 60947-5-1

Type(recommend to adopt)	Operating mode	Type of replacement(discontinue)				
YBLXW-6/11	Component					-ZL/15G10
YBLXW-6/11BZ	Panel mounting plunger type	-AZ/7310	-TZ/7310	-MN/5310	-ZL/15G03	-D4MC/5000
YBLXW-6/11CA	Long press-button type					
YBLXW-6/11DA	Short press-button I type	-AZ/7110	-TZ/7110	-MN/5110	-ZL/15G01	
YBLXW-6/11DA2	Short press-button II type	-AZ/7100	-TZ/7100	-MN/5100		
YBLXW-6/11CG	Long triangle type	-AZ/7120	-TZ/7120	-MN/5120	-ZL/15G060	-D4MC/1000
YBLXW-6/11DG	Short triangle type	-AZ/7140	-TZ/7140	-MN/5140	-ZL/15G06	-D4MC/1020
YBLXW-6/11CL	Long spar roller type	-AZ/7121	-TZ/7121	-MN/5121	-ZL/15G07	-D4MC/2000
YBLXW-6/11DL	Short spar roller type	-AZ/7141	-TZ/7141	-MN/5141	-ZL/15G09	-D4MC/2020
YBLXW-6/11CDL	Long spar one-way roller type	-AZ/7124	-TZ/7124	-MN/5124		
YBLXW-6/11DDL	Short spar one-way roller type	-AZ/7144	-TZ/7144	-MN/5144	-ZL/15G070	-D4MC/3030
YBLXW-6/11HL	Lateral roller type	-AZ/7312	-TZ/7312	-MN/5312	-ZL/15G031	-D4MC/5040
YBLXW-6/11ZL	Straight roller type	-AZ/7311	-TZ/7311	-MN/5311	-ZL/15G030	-D4MC/5020
YBLXW-6/11W1	Universal I type	-AZ/7161	-TZ/7161	-MN/5161		
YBLXW-6/11W2	Universal II type	-AZ/7166	-TZ/7166	-MN/5166		
YBLXW-6/11W3	Universal III type	-AZ/7169	-TZ/7169	-MN/5169		

Model	Performance characteristic	Movement (OF)max	Reset force (RF)min	Movement route (PT)max	Overtravel (OT)min	Distance route (MD)max	Freedom position (FP)max	Operating position (OP)
YBLXW-6/11BZ		6N	1N	2.5mm	2.5mm	1.2mm	-	21.8±1.2mm
YBLXW-6/11CA		6N	1N	2.5mm	2.5mm	1.2mm	-	21.8±1.2mm
YBLXW-6/11DA		6N	1N	2.5mm	2.5mm	1.2mm	-	44±1.2mm
YBLXW-6/11DA2		6N	1N	2.5mm	1mm	0.8mm	-	30±1mm
YBLXW-6/11CG		2N	0.25N	5mm	4mm	3mm	36mm	25±1mm
YBLXW-6/11DG		3N	0.35N	4mm	2.5mm	1.5mm	32mm	25±1mm
YBLXW-6/11DL		2N	0.4N	5mm	5mm	2.4mm	51mm	40±1.2mm
YBLXW-6/11CL		3N	0.4N	4mm	2mm	1.5mm	47mm	40±1.2mm
YBLXW-6/11DL		2N	0.4N	5mm	5mm	2.4mm	57mm	50±1.2mm
YBLXW-6/11CDL		3N	0.4N	4mm	2mm	1.5mm	55mm	50±1.2mm
YBLXW-6/11DDL		6N	1N	1.6mm	3mm	1.2mm	-	33.4±1.2mm
YBLXW-6/11DDL		6N	1N	1.6mm	3mm	1.2mm	-	33.4±1.2mm
YBLXW-6/11HL		2N	-	35°	-	-	-	-
YBLXW-6/11ZL		2N	-	35°	-	-	-	-
YBLXW-6/11W1		2N	-	35°	-	-	-	-

YBLXW-6/11W2

YBLXW-6/11W3

4. Overall and mounting dimensions

YBLXW-6/11

YBLXW-6/11ZL

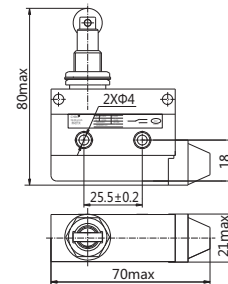
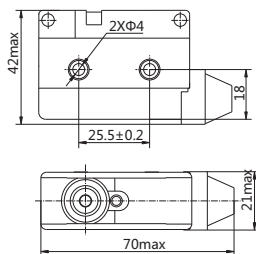

Microswitch

YBLXW-6/11HL

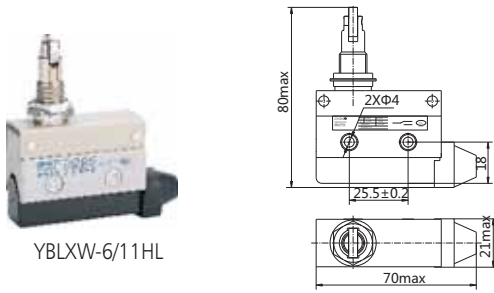

YBLXW-6/11HL

YBLXW-6/11DG

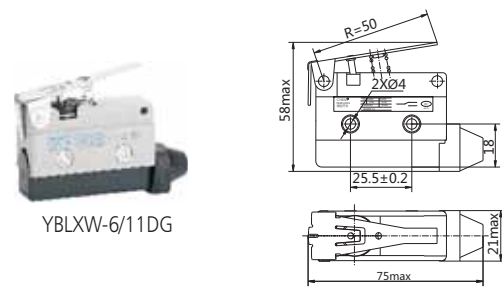

YBLXW-6/11DG

YBLXW-6/11DL

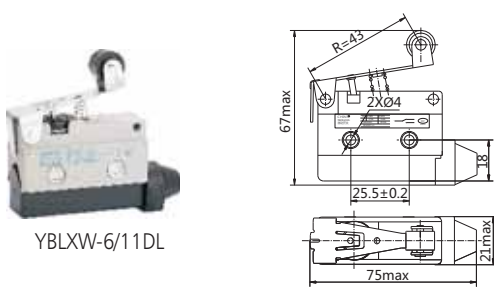

YBLXW-6/11DL

YBLXW-6/11BZ

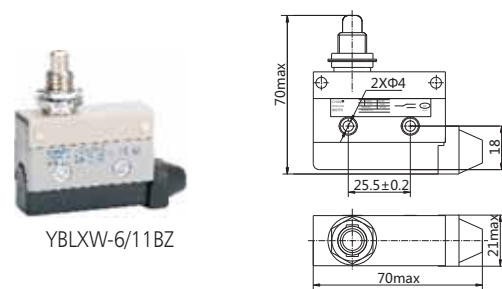

YBLXW-6/11BZ

YBLXW-6/11CG

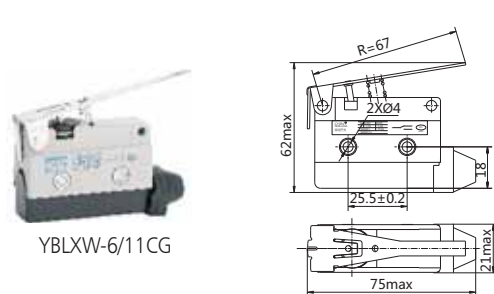

YBLXW-6/11CG

YBLXW-6/11CL

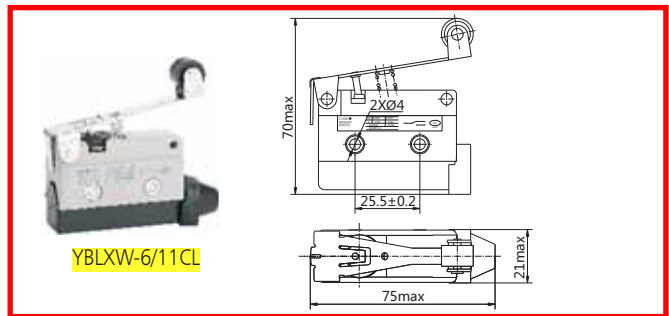

YBLXW-6/11CL

YBLXW-6/11DA

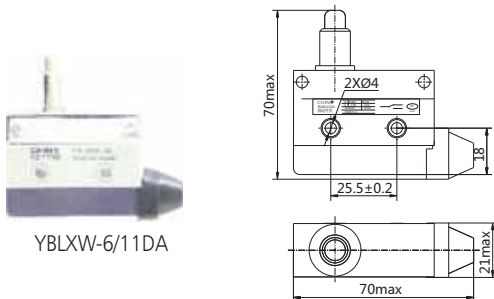

YBLXW-6/11DA

YBLXW-6/11DA2

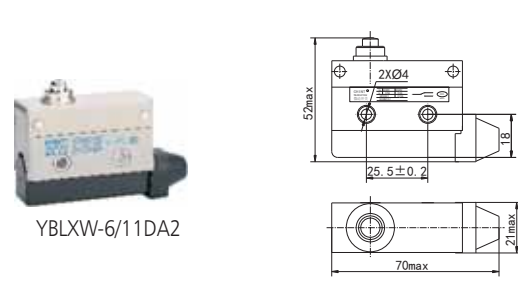

YBLXW-6/11DA2

YBLXW-6/11CA



YBLXW-6/11CA

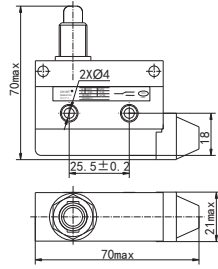

YBLXW-6/11DDL



YBLXW-6/11DDL

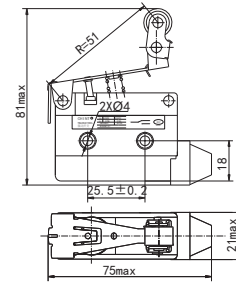

YBLXW-6/11W1



YBLXW-6/11W1

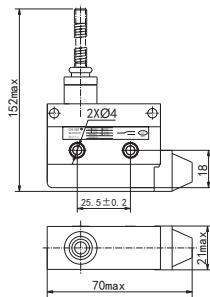

YBLXW-6/11W2



YBLXW-6/11W2

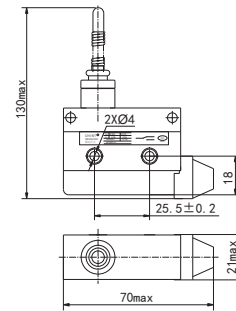

YBLXW-6/11W3



YBLXW-6/11W3

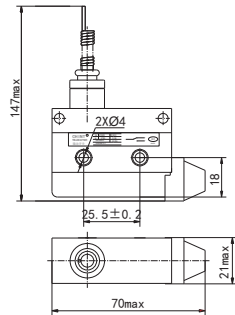

YBLXW-6/11CDL



YBLXW-6/11CDL

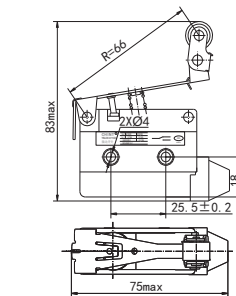

5. Ordering information

Explain the whole type,name and quantities of switches when ordering goods
Such as:YBLXW-5 / 11 Z microswitch 100 pieces